

MACH-24

Rocketry Competition

10th-14th July 2024

Rules & Requirements





Table of Contents

Document Information	4
Introduction	5
Event Details	5
1.1 Overview	5
1.2 The Organising Team	6
Competition Outline	6
1.3 Format.....	6
1.4 Competition Requirements (Category 1).....	6
1.5 Competition Requirements (Category 2).....	7
1.5.1 Rocket Motor Selection / Procurement	7
1.5.2 Altitude Scoring	8
1.5.3 Payload	8
1.6 Competition Requirements (Category 3).....	8
1.7 Rules and Regulations	9
1.7.1 Teams	9
1.7.2 Team's Facilities & Resources	9
1.8 Costs & Provided Services.....	10
1.9 Documentation and Deliverables	12
1.9.1 Initial Outline Design	12
1.9.2 Preliminary Design Review	12
1.9.3 Critical Design Review	12
1.9.4 Flight Readiness Review.....	12
1.9.5 Launch Operation.....	12
1.9.6 Post-Flight Review	13
1.10 Scoring.....	14
1.10.1 CanSat Only	14
1.10.2 Combined Entry	15
1.10.3 Penalties & Violations	16
1.10.4 Prizes	16
Event Rules	17
1.11 Rules	17
Timeline	18
1.12 Competition Timeline	18
II - Technical Guidelines	19
1. Introduction	19



2. Interface of the Rocket Motor	19
2.1. Mounting of the Motor in Rocket	19
2.2. Motor Mount Strength Requirements	20
2.3. Recommendations	20
3. Performance Margin	21
3.1. Minimum Speed	21
3.2. Static Stability Margin.....	21
4. Structural Acceptance Requirements	22
4.1. Fin Alignment	22
4.2. Fin Longitudinal Loading	22
4.3. Fin Lateral Loading	23
4.4. Fuselage Stiffness.....	23
4.5. Static Strength Requirements	25
5. Electrical System Layout	26
5.1. Internal Power Supply	26
5.2. Electrical Considerations.....	26
6. Recovery Requirements (emphasising 2-stage)	27
6.1. Use of Recovery System.....	27
6.2. Landing Speeds	27
6.3. Maximum Post-Apogee Range	27
6.4. Isolation of Recovery Circuit	28
6.5. Detection of Apogee.....	28
6.6. Flight Computer Disarming Mechanism	28
6.7. Validation of Flight Computer.....	28
6.8. Integrity of Circuit under Force.....	28
6.9. Transmission of Recovery Shock Loads	28
7. Launch Rail Information	29
Appendices	30
Appendix 1 – Motor Assembly Technical Drawings	30
Resources	39
Reading List	39



Document Information

Version Number	Changes	Date
Draft		07/09/2023
V1.0	Updated table of maximum impulse, added a summary of requirements to guidelines	03/10/2023
V1.1	Updated Entry Fee Cost	15/11/2023
V1.2	Updated Accommodation Cost	05/12/2023
V1.3	Updated Design Reviews Dates	11/01/2024



Introduction

Mach-24 Launch Competition encompasses the high-level vision for an advanced high-powered rocketry competition within the UK, targeted primarily at University teams with some previous rocketry experience. The aim of this competition is to be complementary to the UKSEDS National Rocketry Championship and build on the experience of the past Mach-X competitions.

The end goal is to enable students to design, build and operate large rockets (impulse equivalent to a level 1 & level 2 certification) and technical payloads in a competitive environment, while implementing an “ESA” Design Review processes (Preliminary Design Review, Critical Design Review, Flight Readiness Review etc.). Payloads will be in the form of CanSats, satellites within the dimensions of a soft drinks can.

The competition is organised by Discover Space UK, a joint-venture between Exotopic and Machrihanish Airbase Community Company (MACC) and UK Students for the Exploration and Development of Space (UKSEDS).

Broad timescales have been set for each activity required to run the programme, with specific timescales and requirements set forth in this document. Students will register their teams by mid-November 2023, and launch their rockets and CanSats during an event from the 10th – 14th July at Machrihanish Airbase, Scotland. As with the previous three years of competitions, Mach-24 will include hands-on training elements (recovery system design and packing, ground testing and more!) and the opportunity for participants to engage with members of the UK Space Industry.

Furthermore, the teams are required to write a reflection on their experiences in the competition and engage with activities of outreach. The teams are also invited to add some rocketry tips to their reports, which will then be published on the website and used for future reference.

Event Details

1.1 Overview

Mach-24 is an opportunity for students to develop their practical, hands-on mechanical and electrical skills by designing, building and flying rockets CanSats of their own creation. This event is not only focussed on build & launch events but will provide an opportunity for hands-on training, as we understand the importance of skills development, team building and with future employers and fellow space enthusiasts for students looking to graduate into the fast growing and stimulating UK Space sector. Students will be able to use this opportunity to begin to build and expand their space industry networks.



1.2 The Organising Team

Exotopic	MACC	UKSEDS	Safety & Technical Experts
Sara Lai	Malcolm McMillan	Robert McLeod	Chris Brown
Rosie Cane	Dave Cook	James Hollingdale	Colin Rowe
Andy Grey	Mary Dott / Lindsey Semple	Kaleb Mead	
	Tim Bailey		

Competition Outline

1.3 Format

The competition format has been split into three categories and teams will choose the target categories in which to compete.

Category 1 - Aim: Design and build a CanSat following a set mission criteria

Category 2 - Aim: Launch to as close to a set altitude (between 1.5km & 3km) as possible

Category 3: Rocketry Challenge – Aim: Innovation!

Entries to all the categories will be marked on their ability to design and construct a payload in the form of a CanSat, with marks awarded for the inclusion of an altimeter, GPS and innovation.

The competition will culminate in a 4-day launch event at Machrihanish Spaceport. The programme for the launch event is to be confirmed in early 2024.

1.4 Competition Requirements (Category 1)

Entries to Category 1 (CanSat only) must follow the mission objectives outlined below:

- **Mission Statement:** The CanSat mission for this year is to link to **sustainability**. Each team must select an experiment for their CanSat to conduct relating to this (e.g., use of recycled components, use of solar panels etc). CanSats will be marked on how well each team has completed their mission.
- Each CanSat must include standard sensors to measure altitude and GPS.
- Each CanSat must include a **back-up tracking system**.
- Each CanSat must have capability for data acquisition & storage (telemetry).
- Each CanSat **must be deployable from the launch vehicle**.
- Each CanSat must have either **deploy a permanent recovery device** (i.e parachute or streamer) upon release from the launch vehicle or **use a COTS altimeter** to deploy said recovery device. Drift calculations for the CanSat must



show that the CanSat will land within 1.5km of the launch site with the forecast winds.

The criteria for the CanSat are summarised in the table below:

Table 1. CanSat Mission.

Mission
<ol style="list-style-type: none">1. Sustainable CanSat2. Deployment from launch vehicle3. COTS:<ul style="list-style-type: none">• Altitude Measurement• GPS4. Telemetry

Alongside this, the CanSat must meet the following additional requirements:

Size: The CanSat must fit the following dimensions; 115 mm diameter x 160 mm height.

Mass: The mass of the CanSat for this category, including recovery systems, must be a **minimum of 900g and maximum of 1kg.**

Recovery System: The CanSat must have a suitable recovery system to support safe descent for launch of up to 600 metres.

CanSats in Category 1 will be launched using DSUK's launch vehicles.

1.5 Competition Requirements (Category 2)

The process of gathering requirements is on-going and we will culminate in the dissemination of rules and regulations, which are either already in line with the respective national requirements for safe and effective launch operations or can be easily adapted to fit.

All rockets for Category 2 must be designed, assembled and flown in accordance with the UKRA Safety Code.

1.5.1 Rocket Motor Selection / Procurement

Due to safety and competition restrictions, only approved motors can be used in Mach-24. We will not allow self-made motors or motors from unlicensed manufacturers.

All teams must select a commercial of-the-shelf (COTS) Solid Motor for use during the competition. At the end of this document you will find a list of UK vendors from whom you can purchase your motor.

Motors can be delivered directly to, and stored on-site, at Machrihanish Airbase, at the following address:



Mach-24 Launch Competition

Building 79, MACC Business Park
Campbeltown
PA28 6NU

Teams are limited on motor based on the category they enter into Mach-24.

1.5.2 Altitude Scoring

Category	Maximum Impulse	Maximum Motor Class	Target apogee	UKRA Level
2	640Ns	I-class	1.5km	1
2	5120Ns	L-class	3.0km	2

Teams will be marked on how close they can get the apogee of their launch vehicle to the altitude outlined above.

1.5.2.1 Testing & Recovery

The full testing specification is outlined in the design review process. Testing of the following will need to be confirmed prior to launch:

- Recovery system
- Avionics
- Airframe structure
- Stability

We require all entered launch vehicles to have a dual deployment and be recovered substantially intact.

1.5.3 Payload

The purpose of a rocket is to transport a payload to an altitude; therefore, all entries in Category 2 are required to carry a payload of at least 1kg, including recovery systems.

The payload must be in the form of a CanSat, of which dimensions (size is not relevant as long as it is within the dimensions of a can), integration and function are down to the individual team's discretion, given it complies with the UKRA Safety Code, Primary Mission stated below and Mach-24 Competition Rules.

The CanSat mission is as stated in Table 1.

1.6 Competition Requirements (Category 3)

The process of gathering requirements is on-going and we will culminate in the dissemination of rules and regulations, which are either already in line with the



respective national requirements for safe and effective launch operations or can be easily adapted to fit.

All rockets for Category 3 must be designed, assembled and flown in accordance with the UKRA Safety Code.

Category 3 was created in order to test your technical skills and push innovation in your designs. Innovation can be manifested as (but not limited to):

1. Your CanSat is a **UAV**
2. Your rocket is **two staged**
3. Your propulsion system is a **cluster of motors**

Multistage or cluster configurations allowed, given maximum impulse, are not surpassed. If multistage, rocket must have COTS system for determining if rocket is vertical before igniting second stage.

Note: we are in the process of reviewing the altitude cap if you choose to launch a two-staged rocket.

The rules on Motor Selection, Testing & Recovery are as depicted in sections 1.5.1, 1.5.2.1 above.

Your payload must weigh at least 1 kg, and must contain at least 1 sustainable component.

1.7 Rules and Regulations

1.7.1 Teams

Teams working on an entry can be up to 15 members, but we will only be able to accommodate 6 members per team during the event in June/July. Team members must be undergraduate or MSc students and have a named academic contact at their university, who is willing to engage in the competition and progression of your entry. PhD students are permitted to join a team, as long as the team is majoritively comprised by undergraduate and MSc students.

We will revisit the number of team members allowed to attend the full event based on capacity when registration has closed. All team members will be welcome to attend the launch of their entries to Mach-24, but will need to provide their own travel, accommodation, and catering.

1.7.2 Team's Facilities & Resources

Given the nature of the competition, it is natural teams will have varying levels of access to facilities and resources. For example, a team might have access to an electronics laboratory or wind tunnel, while others will not. This is a reflection of the realities of the industry, which can breed innovation and creativity. However, to ensure



fair competition there have to be some guidelines regarding what resources are allowed.

Allowed	Not-allowed
Creation of hardware and software by third parties to student's design specification (with approval by Mach-24 committee)	Student built/modified rocket motor
Industry sponsorship	Student built avionics that have control over any aspect of flight or recovery
Academic and/or Industry mentorship	

1.8 Costs & Provided Services

The Mach-24 Committee and its sponsors will cover the majority of costs for the event.

We will provide:

- A coach from Glasgow to the launch site
- On-site camping
- Catering for all participants whilst on site
- Space skills Workshops
- Launchpad and rail
- Launch controller
- Launch site
- Range Safety Officers
- Site insurance

What isn't provided:

- Travel to/from Glasgow
- Rocket/payload components
- Event entry fee
- Launch insurance. **To be covered by launch insurance you are required to have group BMFA membership. Please refer to the [BMFA website](#).**

To accommodate an envisioned increased capacity for this year's event, the standard entry fee will include access to the site for camping. For any teams which wish to book the on-site accommodation at the airbase, an additional fee will be required on top of standard entry, as seen below.

Entry	Fee per team
Standard Entry (Camping)	Category 1&2: £650 Category 3: £800
Room in on-site Accommodation	£108pp



Accom fee will be total price per person for 4 nights. Note: the standard entry fee does not vary with number of team members.

We hope that university departments will support with these fees. If you have any issues with the amount shown or would like support, please contact us at info@exotopic.com.



1.9 Documentation and Deliverables

Templates will be provided for the below design review stages in advance to assess teams progress and designs for the competition and allow the Mach-24 committee to examine and provide feedback on the design of the CanSat and the rockets. These are as follows:

1.9.1 Initial Outline Design

The Initial Outline Design will be a one-page document, covering system requirements prior to design reviews. The following will be included:

- Overview of launch vehicle and CanSat design performance requirements
- High-level risk analysis and mitigation
- Plan of action to meet competition timelines

1.9.2 Preliminary Design Review

The Preliminary Design Review will be in the form of a slide pack, presented by the team via recording and submitted to the Mach-24 committee for review. This will include:

- Introduction & mission statement
- Design concept for launch vehicle and CanSat payload
- Project management (team/roles, preliminary schedule & budget)
- Safety management
- Manufacturing considerations (how/who, tolerances, etc)

1.9.3 Critical Design Review

The critical design review will be in the form of a slide pack, covering:

- Introduction (statement and objectives)
- Project Management (schedule & budget)
- Safety management
- Detailed designs for launch vehicle and CanSat payload
- MAIT (Manufacturing, Assembly, Integration and Test)

1.9.4 Flight Readiness Review

A further review closer to the launch day, similar to the design review, but will also include testing methods and results. This will be in the form of a slide pack, covering:

- Introduction (statement and objectives)
- Detailed MAIT
- Demonstration that both launch vehicle and CanSat payload will be safe and ready to fly

1.9.5 Launch Operation

Provided the entered design has passed all checks, the launch vehicle and payload will be given opportunity to launch. This is weather permitting and in the case of a launch scrub due to adverse condition, effort will be made by the Mach-24 committee to make alternative arrangements.



1.9.6 *Post-Flight Review*

The Post-Flight Review will consist of a 5-10 minute presentation, covering:

- Design summary
- Data analysis from launch
- Performance evaluation
- Future work/review



1.10 Scoring*

The scoring system for Mach-24 has been split into the categories of entry below. These are as follows:

1.10.1 CanSat Only

Scoring	Points	Percentage
1. Payload	120	34.3%
Novelty & Innovation	30	8.6%
Successful Deployment	40	11.4%
Success of Mission	50	14.3%
2. Documentation	210	60%
Preliminary Design Review	50	14.3%
Critical Design Review	80	22.8%
Flight Readiness Review	50	14.3%
Post-Flight Review	30	8.6%
3. Team Reflection and Future Work	20	5.7%
Writing up the team's experiences in the competition and rocketry tips. It will be published after the event to encourage more people into rocketry.	20	5.7%
Total	350	100%

*subject to amendments. To be finalised by January 2024.



1.10.2 Combined Entry

Scoring	Points	Percentage
1. Flight Performance	250	40%
Distance from set altitude	200	29%
Successful parachute deployment as advertised	50	11%
2. Payload	120	20%
Novelty & Innovation	30	5%
Successful Deployment	40	6.6%
Success of Mission	50	8.4%
3. Documentation	210	35%
Preliminary Design Review	50	8.4%
Critical Design Review	80	13.2%
Flight Readiness Review	50	8.4%
Post-Flight Review	30	5%
4. Team Reflection and Future Work	20	5%
Writing up the team's experiences in the competition and rocketry tips. It will be published after the event to encourage more people into rocketry.	20	5%
Total	600	100%



1.10.3 Penalties & Violations

It is unforeseen that any team will explicitly violate the rules resulting in gross misconduct, however, if any issues arise that can be deemed a violation the Mach-24 committee will investigate and determine an adequate response such as disqualification.

1.10.4 Prizes

Each category will receive a 1st and 2nd place prize. These will be as seen below:

Placing	Prize
1 st	<ul style="list-style-type: none">• Mach-24 trophy• Certificate of achievement
2 nd	<ul style="list-style-type: none">• Mach-24 trophy• Certificate of achievement

Additional awards will be given according to the following criteria:

- Most Original Design
- Best Post-Flight Review presentation
- Best Outreach



Event Rules

1.11 Rules

1. All rocketry activities must abide by the United Kingdom Rocketry Association (UKRA) Safety Code, which can be found [here](#).
2. An RSO on site will conduct the launches during the event, student teams must provide them with all launch information beforehand.
3. All rockets must be original designs and scratch built by members of the team. Commercial kits are not permitted.
4. All designs must be capable of measuring altitude. The altimeter needs to be tested and calibrated prior to installation to ensure it is in working condition. This process should be documented in the build and design report. Teams can make their own altimeter for deployment of recovery devices or buy a commercially available device. The teams are allowed to use their own altimeter only if it is already UKRA approved.

NB: In order to be UKRA approved, a total of 10 launches must be performed.

Contact us if you need any assistance.

5. All launches must be performed entirely through the motor's own power. No speciality launch systems (i.e., Rockoon, projectile launching) are permitted.
6. If a group wishes to use their own telemetry system, then the equipment to be used at the launch site must be certified by the Radio Standards Authority and subsequent documentation submitted to the RSO on the day of the launch as part of the pre-launch checklist.
7. If a group wishes to control the re-entry of their CanSat (i.e., making it a UAV) they must sign up for Category 3. For more information on drones licensing and permission to fly your drone, consult the CAA website [here](#).
8. A back-up localisation system (e.g., tracking tag) must be included to your design. **The absence of a tracking back-up system may result in your launch being cancelled.**



Timeline

1.12 Competition Timeline

Deadline	Date*
Registrations Opens	20 th October 2023
Registration Closes	17 th November 2023
Outcome Received	20 th November 2023
Welcome Seminar	1 st December 2023 (TBC)
Initial Outline Design	22 nd December 2023
Preliminary Design Review	9 th February 2024
Critical Design Review	12 th April 2024
Flight Readiness Review	14 th June 2024
Team Reflection and Future Work	5 th July 2024
Launch Event	10 th – 14 th July

*subject to changes based on exams.



II - Technical Guidelines

1. Introduction

This technical guidance has been compiled with the aim of providing useful and often necessary information for all those participating in the Mach-24 Launch Competition. It contains technical guidelines recommended for a safe flight, together with concise explanations of the reasons behind them.

The safety requirements in this guidance material is based on the United Kingdom Rocketry Association (UKRA) safety code, with a few additional requirements that the Mach-24 organising team feel are necessary for the purpose of the competition. UKRA is an organisation run by members of the British rocketry community. It is the recognised body for safe high-power rocket flying, and provides third-party insurance, and safe codes of practice. Team members may wish to join UKRA and pursue the UKRA certification scheme, so that they can take up high power rocketry as a hobby.

If a team requires further clarification and explanation of any of the information set out in this guidance, they should contact the Mach-24 organisers (sara.lai@exotopic.com).

Apart from the Mach-24 requirements, many design suggestions are also included in this document. These are based on the collective experience gathered from many rocket projects over the years. These are not mandatory but are intended to be of use.

2. Interface of the Rocket Motor

2.1. Mounting of the Motor in Rocket

Teams must provide a means of securely mounting the motor with the rocket. This mount must transmit the thrust loads from the motor to the structure of the rocket, provide axial alignment of the motor within the rocket and prevent it slipping out during handling and all flight phases.

An example motor mount arrangement is shown in figure 2.1.

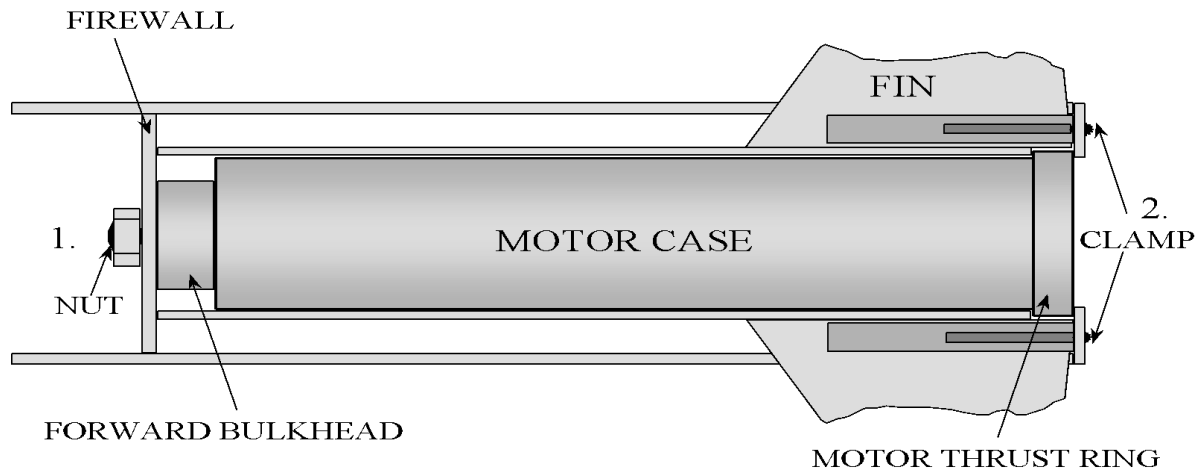

Figure 1.

As suggested in the figure, the motor can either be (1) secured to a firewall by a bolt or (2) clamped at the motor thrust ring to the base of the rocket (similarly a motor retainer may work). Please remember this configuration is just an example and will not work for everyone's purposes.

2.2. Motor Mount Strength Requirements

The motor mount must be designed to take all the thrust loads, both axial and lateral via the motor thrust ring (referred to in Figure 1). It must be designed to withstand and transmit into the body tube a force equivalent to twice the maximum motor thrust without permanent deformation. The mount must withstand a lateral force in any direction equal to a thrust misalignment of 5° at the maximum thrust value cantilevered about the vehicle's centre of gravity after firing.

It is recommended to include any calculations and or tests in the CDR presentation.

2.3. Recommendations

It is suggested NOT to 3D print any motor mounts or interfaces in order to avoid grinding the inner structure of the rocket. Contact us prior to any use of 3D printing. It is further recommended to design the rocket based on the motor's shape, size and specifications.

3. Performance Margin

All rockets participating in Mach-24 must comply with certain stability criteria. Normally, stability will be verified using slender body theory.

For slender body theory to apply, the following four constraints are set on the vehicle:

1. Rockets must have a length to diameter ratio (L/D) which lies between 10 and 35
2. The normal force coefficient C_N must be greater than 15 and less than 30.
3. The vehicle is flying at subsonic speeds.
4. The fins are of thin cross-section.

If the basic criteria given above cannot be met, further documentation must be presented to the RSO to demonstrate that the rocket is both statically and dynamically stable.

3.1. Minimum Speed

When the rocket leaves the launch pad, it should have a minimum velocity of 20 m/s. This corresponds to an average acceleration of 50 m/s^2 over the first four metres of flight.

3.2. Static Stability Margin

The static stability margin (distance between the centre of mass and the centre of pressure) must be between 1.5 diameters and 2.5 diameters during all phases of flight before recovery (see figure 3.1).

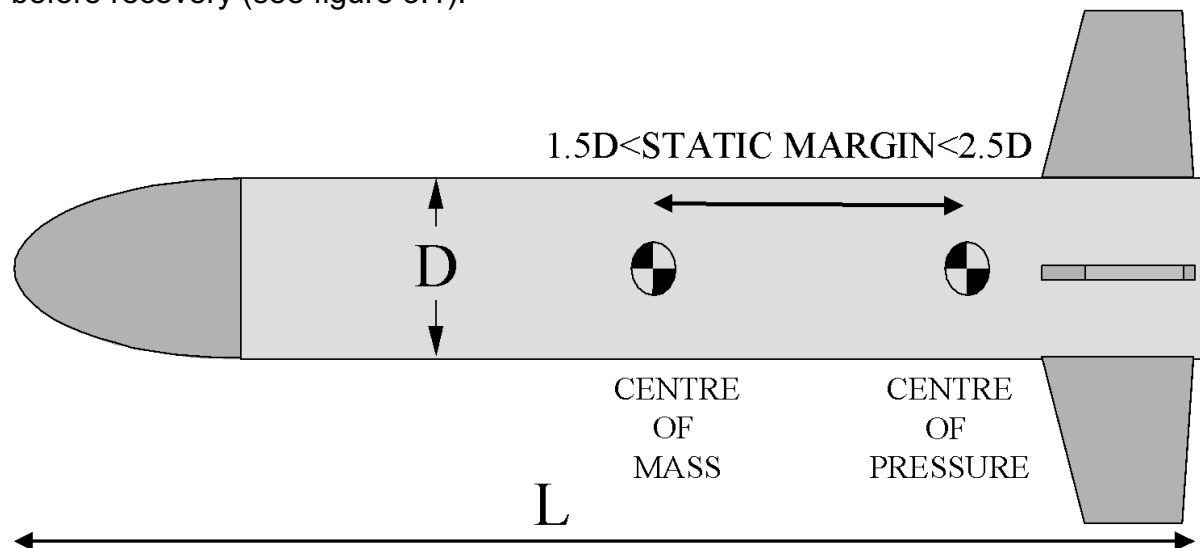

Figure 3.1

4. Structural Acceptance Requirements

For a rocket to be accepted for launch it must pass certain pre-launch criteria in the Flight Readiness Review, which include structural tests. Passing these tests will not guarantee that a rocket will have a flawless flight but will ensure that there is a minimum chance of failure and the rocket will be safe to fly.

4.1. Fin Alignment

The geometric alignment of each fin must be within 2° of the projected longitudinal axes of symmetry of the rocket (see fig 4.1).

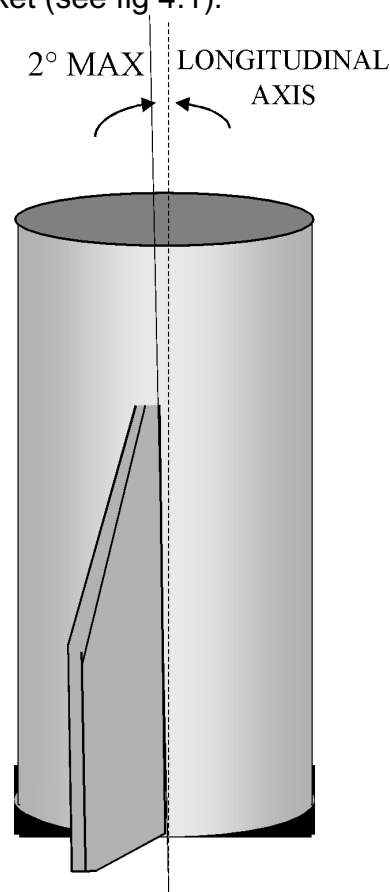

Figure 4.1

4.2. Fin Longitudinal Loading

Each fin must be able to support a suspended load from its tip equal to twice the fin mass times the rocket's maximum axial acceleration occurring during any flight phase (fig 4.2)

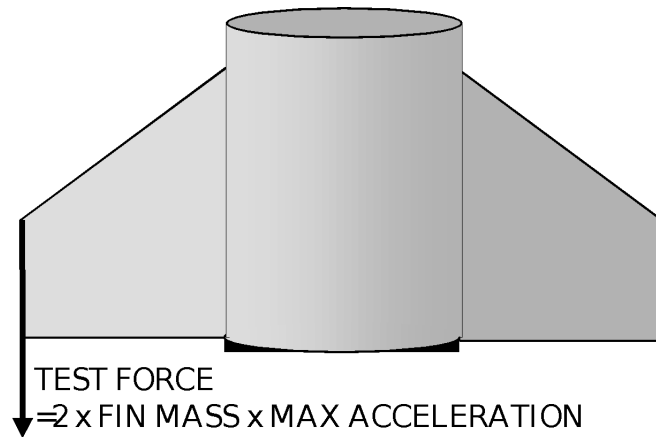

Figure 4.2

4.3. Fin Lateral Loading

Each fin must withstand a transverse load equal to the rocket's launch mass when suspended from the fin tip. When subjected to this load, the maximum lateral deflection measured at the tip must be less than 10° in either direction.

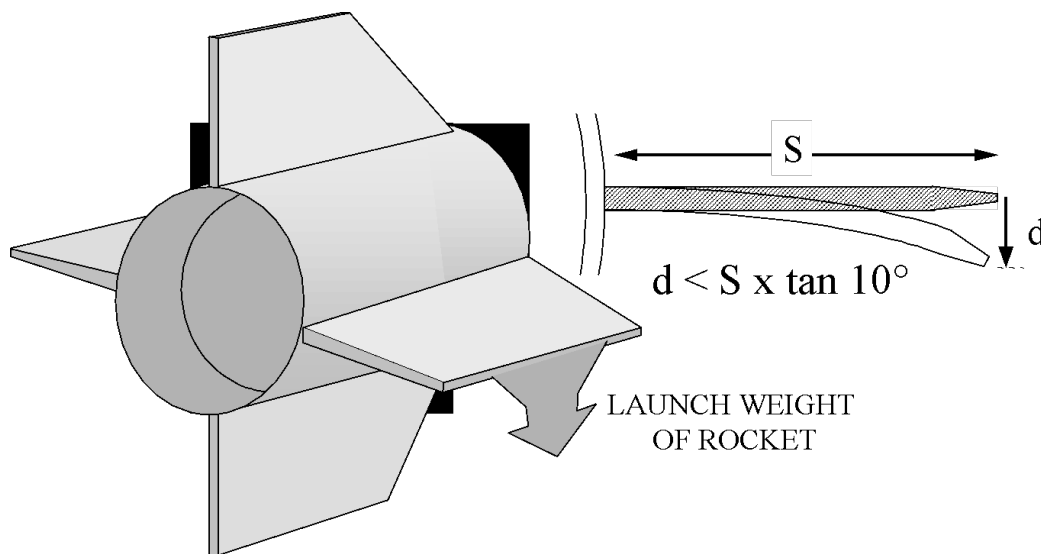

Figure 4.3

4.4. Fuselage Stiffness

When a fully assembled and loaded rocket is suspended from its centre of mass it must produce a lateral deflection in any direction of less than 0.01 radian = 10mm deflection per metre length.

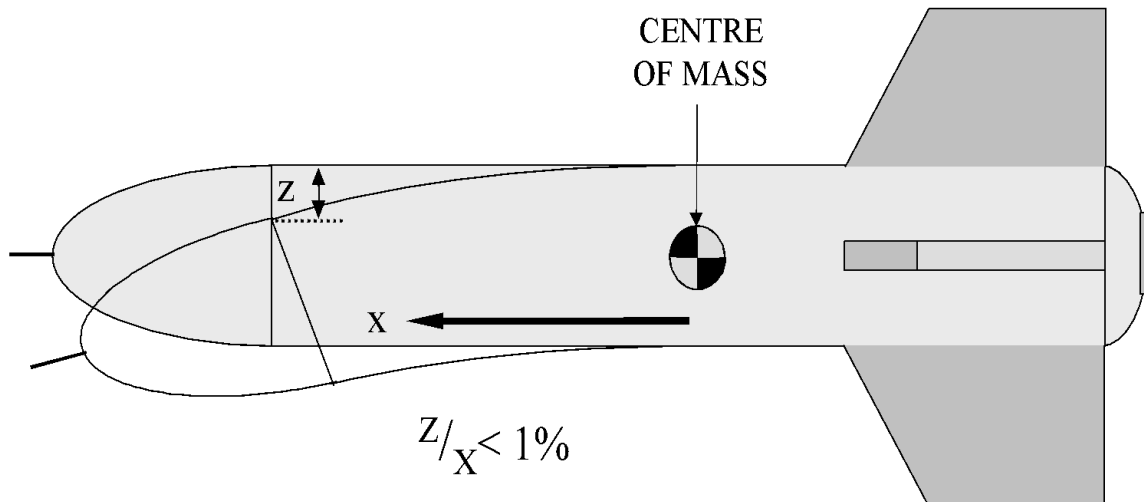

Figure 4.4

When a rocket is coupled together from several tubes, the method of joining the tubes is left to the application and discretion of the designer. However, it is recommended that the mating length between the coupler and each tube should be a minimum of 1 diameter when using plastics or composites and a minimum of 1/2 a diameter when using metals (see figure 4.5). This is advised to maintain satisfactory levels of stiffness along the length of the rocket.

Be aware 3D printed couplers require careful thought and testing.

For sliding connections, the minimum mating length between coupler and tube should always be 1 diameter. Additionally, the fit between parts must stop any noticeable rotation at the joint.

Figure 4.5

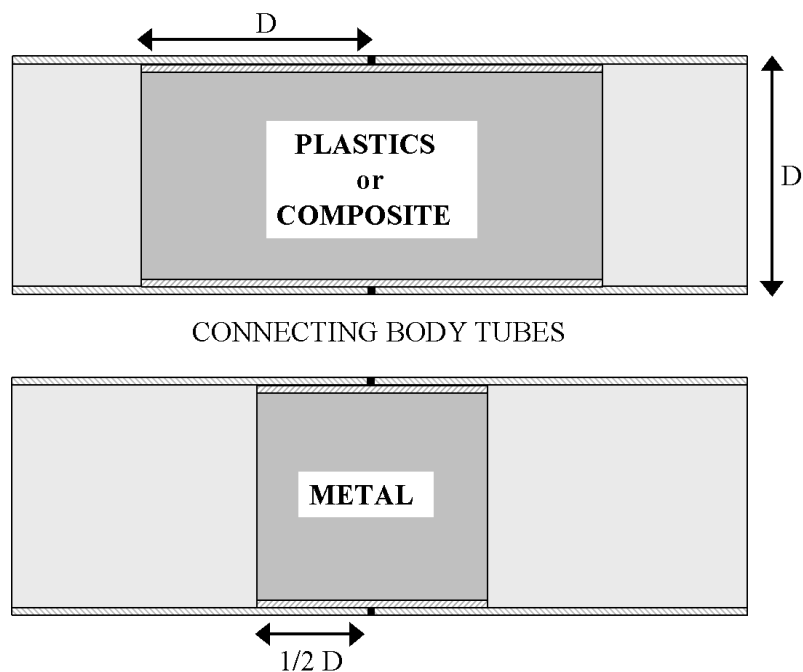



4.5. Static Strength Requirements

All calculations in the critical design review must prove that all structural parts can withstand twice the inertial and aerodynamic loads on them during all phases of flight without failure.

If participants wish to re-use their vehicles, all parts must withstand 1.5 X applied loads without permanent deformation (yield).



5. Electrical System Layout

There are going to be several electrical subsystems onboard a rocket such as payloads, a telemetry system, and a flight computer to control the recovery system.

5.1. Internal Power Supply

The rocket must be capable of being switched on and left to run autonomously using its internal power source for up to 30 minutes on the launch pad.

This should be budgeted for in addition to the energy used during the predicted total flight time.

5.2. Electrical Considerations

It is strongly recommended that single strand wire not be used as electrical cable for primary systems since it is considered too fragile. Multi-strand wire is tougher and more reliable under handling and flight conditions.

During assembly, testing and flight, electronic circuits and wiring are subjected to a high level of abuse. This requires that construction should be rugged, tidy and of a high standard of workmanship as possible. The use of hot melt glue on connectors is advised.

Care should be taken when using electromechanical components (such as relays, switches, and connectors) to ensure that they are capable of withstanding high acceleration and vibration loads. For some types of component (e.g. slide switches) orientation is important.



6. Recovery Requirements (emphasising 2-stage)

6.1. Use of Recovery System

All rockets must have a system to recover them in a safe and controlled manner. This usually takes the form of a parachute that is activated when the rocket reaches apogee.

In order to minimise drift a two stage recovery system is recommended.

Recovery device does not have to be within volume of a drinks can.

6.2. Landing Speeds

The recovery system must reduce the rocket's vertical landing speed to less than 15 m/s. This speed must be demonstrated by documented calculation in the critical design review presentation.

6.3. Maximum Post-Apogee Range

After apogee, the rocket must not drift more than 1.5 km before landing in all wind speeds up to and including 15mph.

The prospective launch site is quite windy, but all rockets must still land within the landowner's boundaries. **It is advisable to make the recovery device highly visible to assist tracking.**

Motor Ejection Charge

Certain motors have an adjustable ejection charge which can be used to trigger the recovery system. This is a relatively passive approach, as the recovery system will deploy at a fixed time after burnout no matter what stage of flight the rocket is in. So premature and late deployment is common using this method.

Some delays are only adjustable to certain time intervals from a maximum so you have a limited amount of options for delay times e.g. 13 seconds, 10 seconds, 8 seconds, 6 seconds and 4 seconds.

Flight Computer

The purpose of the flight computer is to activate the recovery system when the rocket reaches apogee.

COTS flight computers are easily available and use barometric sensors to determine altitude (hence apogee). The simplest deployment computers (e.g. Eggtimer Quark or PerfectFlite StratoLoggerCF) allow recovery devices to be deployed at apogee and at a fixed lower altitude. COTS flight computers with more functions (e.g. Eggtimer Proton) are also available that allow more events to take place at different phases of flight.

All on-board flight computers must be COTS or approved by the UKRA Safety & Technical (S&T) Committee prior to launch.



Teams which wish to use their own flight computer must contact us as early as possible to go through the required flight testing to be used in the competition.

6.4. Isolation of Recovery Circuit

It is recommended that all of the recovery sequencing circuitry be electrically isolated (including battery) from any other electrical circuit used in the rocket.

It is important that special attention is paid to the design of the recovery system sequencing circuit. This is one of the most safety critical components. Good design will produce a safe and reliable system.

The sequencing circuit consists of three main parts: the **launch detector**, the **altitude determination** and the **actuator**. Most systems available already have these built in, and teams are encouraged to use these.

6.5. Detection of Apogee

Detectors relying on the physical orientation of the rocket relative to the gravity vector to detect apogee (e.g. tilt switches) are inaccurate and should not be used.

6.6. Flight Computer Disarming Mechanism

The flight computer must have a safe and secure disarming mechanism, which prevents inadvertent activation of the recovery system during handling and loading (this is especially important where pyrotechnic actuators are used).

The system must be kept in the disarmed (safe) condition until the rocket is safely loaded into the launch pad. At the designated point during countdown the rocket can then be armed.

6.7. Validation of Flight Computer

Teams must demonstrate the reliability and reproducibility of their flight computer and recovery system at the pre-launch checks. If the system contains any expendable components (such as pyrotechnics), a sufficient quantity must be brought to demonstrate the proper functioning of the system.

6.8. Integrity of Circuit under Force

The circuit must be structurally and electrically robust so that no parts of the circuit can change state or function due to any mechanical loads from transportation, manipulation on the launch pad or in flight.

Recovery system deployment shock loads are a very important design case and can exceed the thrust loads. The recovery system design must be well researched and documented in the critical design review.

6.9. Transmission of Recovery Shock Loads

The main recovery shock loads must not be transmitted in shear through screw threads into the rocket body.

It is recommended that these loads be transmitted through links and hook-eye anchor points.

7. Launch Rail Information

The launch rail used for Mach-24 is the Talon launch pad. The pad is an aluminium portable system that can support the launches of rockets up to 25kg in mass. It has three feet, a stainless steel blast-deflector plate and a rail that has a maximum length of 4m which can be locked into position at 5 degree increments from vertical to 20 degrees from vertical. Therefore, rockets must be capable of being launched above 70 degrees to the horizontal.

An end and side view of the Talon Launch Pad rail can be seen in the figure below. A minimum of two buttons are required on the rocket for a stable launch, which should be positioned such that they are aligned vertically along the body tube and such that when sliding the rocket on to the rail – the fins or any other equipment shall not cause an obstruction. There is a 0.8cm slot. The recommended button sizes to fit the rail are standard 1” rail buttons. These are pictured below.

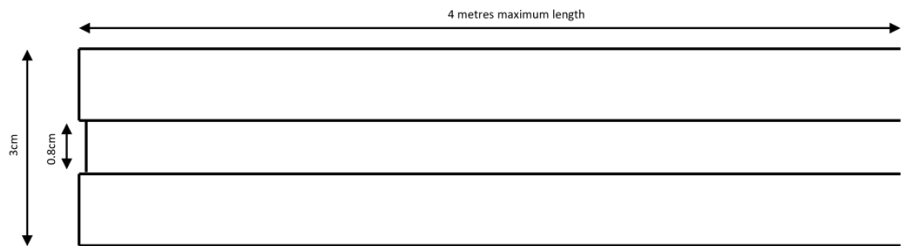
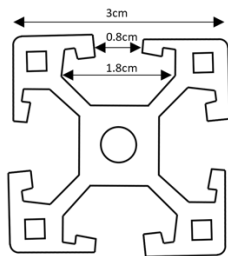



Appendices

Appendix 1 – Motor Assembly Technical Drawings

8	7	6	5	4	3	2	1																																																																																																																							
<p>NOTES:</p> <p>1. MOTOR ASSEMBLY SHOWN WITH OVERALL EXTERIOR DIMENSIONS.</p>							<table border="1" style="width: 100%; border-collapse: collapse;"> <thead> <tr> <th colspan="2" style="text-align: center;">REVISIONS</th> <th style="text-align: center;">DATE</th> <th style="text-align: center;">APPROVAL</th> </tr> </thead> <tbody> <tr> <td style="width: 15%;">REV</td> <td style="width: 55%;">DESCRIPTION</td> <td style="width: 15%;">DATE</td> <td style="width: 15%;">APPROVAL</td> </tr> <tr> <td style="text-align: center;">A</td> <td style="text-align: center;">FIRST RELEASE ISSUE</td> <td style="text-align: center;">10/20/09</td> <td></td> </tr> </tbody> </table>				REVISIONS		DATE	APPROVAL	REV	DESCRIPTION	DATE	APPROVAL	A	FIRST RELEASE ISSUE	10/20/09																																																																																																									
REVISIONS		DATE	APPROVAL																																																																																																																											
REV	DESCRIPTION	DATE	APPROVAL																																																																																																																											
A	FIRST RELEASE ISSUE	10/20/09																																																																																																																												
VIEW AFT CLOSURE							VIEW FORWARD CLOSURE																																																																																																																							
<table style="width: 100%;"> <thead> <tr> <th colspan="3" style="text-align: center;">SUPPLIER DATA</th> <th colspan="4" style="text-align: center;">USED IN THE FOLLOWING PRODUCTS</th> <th colspan="4" style="text-align: center;">UNLESS OTHERWISE SPECIFIED DIMENSIONS ARE IN INCHES</th> </tr> </thead> <tbody> <tr> <td style="width: 25%;">PART NUMBER</td> <td style="width: 25%;">DESCRIPTION</td> <td style="width: 25%;">PART NUMBER</td> <td style="width: 25%;">DESCRIPTION</td> <td style="width: 12.5%;">QTY</td> <td style="width: 12.5%;">PART NUMBER</td> <td style="width: 12.5%;">DESCRIPTION</td> <td style="width: 12.5%;">ITEM</td> <td colspan="4"></td> </tr> <tr> <td colspan="4"></td> <td colspan="2">MATERIAL</td> <td colspan="2">CONTRACT NUMBER</td> <td colspan="4"></td> </tr> <tr> <td colspan="4"></td> <td colspan="2">FINISH</td> <td colspan="2">PREP. BY</td> <td colspan="4"></td> </tr> <tr> <td colspan="4"></td> <td colspan="2"></td> <td colspan="2">CHKD. BY</td> <td colspan="4"></td> </tr> <tr> <td colspan="4"></td> <td colspan="2"></td> <td colspan="2">AVRD. BY</td> <td colspan="4"></td> </tr> <tr> <td colspan="8"></td> <td colspan="4" style="text-align: center;"> <p>LIST OF MATERIAL</p> <table border="1" style="width: 100%; border-collapse: collapse;"> <thead> <tr> <th style="width: 5%;">ITEM</th> <th style="width: 10%;">DESCRIPTION</th> <th style="width: 10%;">QTY</th> <th style="width: 10%;">PART NUMBER</th> <th style="width: 10%;">DESCRIPTION</th> <th style="width: 10%;">QTY</th> <th style="width: 10%;">MATERIAL</th> <th style="width: 10%;">CONTRACT NUMBER</th> <th style="width: 10%;">PREP. BY</th> <th style="width: 10%;">CHKD. BY</th> <th style="width: 10%;">AVRD. BY</th> </tr> </thead> <tbody> <tr> <td colspan="11"></td> </tr> </tbody> </table> </td> </tr> <tr> <td colspan="11" style="text-align: center;"> <p style="font-size: small;">2113 W. 89th N. Street Aurora, CO 80016 (435) 865-7100 (PH) (435) 865-7120 (FAX)</p> <p style="font-size: small;">HP 38/1080 MOTOR DIMENSIONAL DRAWING</p> <p style="font-size: small;">ASSY DWG</p> <p style="font-size: x-small;">SCALE: 1:2.5 SHEET 1 OF 1</p> </td> </tr> </tbody> </table>											SUPPLIER DATA			USED IN THE FOLLOWING PRODUCTS				UNLESS OTHERWISE SPECIFIED DIMENSIONS ARE IN INCHES				PART NUMBER	DESCRIPTION	PART NUMBER	DESCRIPTION	QTY	PART NUMBER	DESCRIPTION	ITEM									MATERIAL		CONTRACT NUMBER										FINISH		PREP. BY												CHKD. BY												AVRD. BY														<p>LIST OF MATERIAL</p> <table border="1" style="width: 100%; border-collapse: collapse;"> <thead> <tr> <th style="width: 5%;">ITEM</th> <th style="width: 10%;">DESCRIPTION</th> <th style="width: 10%;">QTY</th> <th style="width: 10%;">PART NUMBER</th> <th style="width: 10%;">DESCRIPTION</th> <th style="width: 10%;">QTY</th> <th style="width: 10%;">MATERIAL</th> <th style="width: 10%;">CONTRACT NUMBER</th> <th style="width: 10%;">PREP. BY</th> <th style="width: 10%;">CHKD. BY</th> <th style="width: 10%;">AVRD. BY</th> </tr> </thead> <tbody> <tr> <td colspan="11"></td> </tr> </tbody> </table>				ITEM	DESCRIPTION	QTY	PART NUMBER	DESCRIPTION	QTY	MATERIAL	CONTRACT NUMBER	PREP. BY	CHKD. BY	AVRD. BY												<p style="font-size: small;">2113 W. 89th N. Street Aurora, CO 80016 (435) 865-7100 (PH) (435) 865-7120 (FAX)</p> <p style="font-size: small;">HP 38/1080 MOTOR DIMENSIONAL DRAWING</p> <p style="font-size: small;">ASSY DWG</p> <p style="font-size: x-small;">SCALE: 1:2.5 SHEET 1 OF 1</p>										
SUPPLIER DATA			USED IN THE FOLLOWING PRODUCTS				UNLESS OTHERWISE SPECIFIED DIMENSIONS ARE IN INCHES																																																																																																																							
PART NUMBER	DESCRIPTION	PART NUMBER	DESCRIPTION	QTY	PART NUMBER	DESCRIPTION	ITEM																																																																																																																							
				MATERIAL		CONTRACT NUMBER																																																																																																																								
				FINISH		PREP. BY																																																																																																																								
						CHKD. BY																																																																																																																								
						AVRD. BY																																																																																																																								
								<p>LIST OF MATERIAL</p> <table border="1" style="width: 100%; border-collapse: collapse;"> <thead> <tr> <th style="width: 5%;">ITEM</th> <th style="width: 10%;">DESCRIPTION</th> <th style="width: 10%;">QTY</th> <th style="width: 10%;">PART NUMBER</th> <th style="width: 10%;">DESCRIPTION</th> <th style="width: 10%;">QTY</th> <th style="width: 10%;">MATERIAL</th> <th style="width: 10%;">CONTRACT NUMBER</th> <th style="width: 10%;">PREP. BY</th> <th style="width: 10%;">CHKD. BY</th> <th style="width: 10%;">AVRD. BY</th> </tr> </thead> <tbody> <tr> <td colspan="11"></td> </tr> </tbody> </table>				ITEM	DESCRIPTION	QTY	PART NUMBER	DESCRIPTION	QTY	MATERIAL	CONTRACT NUMBER	PREP. BY	CHKD. BY	AVRD. BY																																																																																																								
ITEM	DESCRIPTION	QTY	PART NUMBER	DESCRIPTION	QTY	MATERIAL	CONTRACT NUMBER	PREP. BY	CHKD. BY	AVRD. BY																																																																																																																				
<p style="font-size: small;">2113 W. 89th N. Street Aurora, CO 80016 (435) 865-7100 (PH) (435) 865-7120 (FAX)</p> <p style="font-size: small;">HP 38/1080 MOTOR DIMENSIONAL DRAWING</p> <p style="font-size: small;">ASSY DWG</p> <p style="font-size: x-small;">SCALE: 1:2.5 SHEET 1 OF 1</p>																																																																																																																														

NOTES:
 1. MOTOR ASSEMBLY SHOWN WITH OVERALL EXTERIOR DIMENSIONS.

REVISIONS				
REV	DESCRIPTION	DATE	APPROVED	BY
1	FRST RELEASE ISSUE	10/20/09		

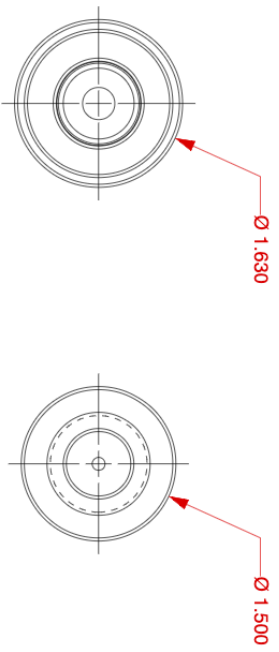
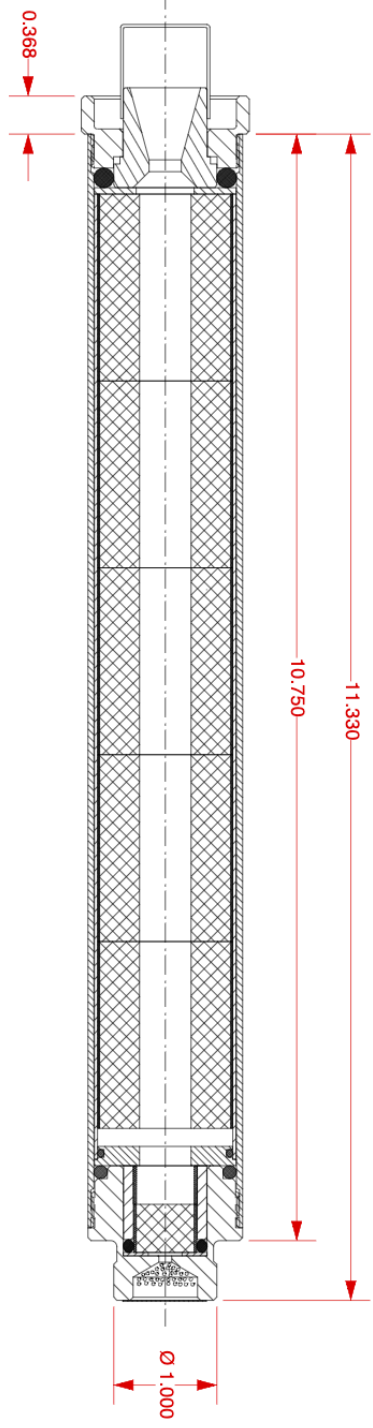

8	7	6	5	4	3	2	1																																												
<p>SUPPLIER DATA</p> <p>USED IN THE FOLLOWING PRODUCTS</p> <table border="1"> <thead> <tr> <th>PART NUMBER</th> <th>DESCRIPTION</th> <th>PART NUMBER</th> <th>DESCRIPTION</th> </tr> </thead> <tbody> <tr> <td> </td> <td> </td> <td> </td> <td> </td> </tr> <tr> <td> </td> <td> </td> <td> </td> <td> </td> </tr> <tr> <td> </td> <td> </td> <td> </td> <td> </td> </tr> <tr> <td> </td> <td> </td> <td> </td> <td> </td> </tr> <tr> <td> </td> <td> </td> <td> </td> <td> </td> </tr> <tr> <td> </td> <td> </td> <td> </td> <td> </td> </tr> <tr> <td> </td> <td> </td> <td> </td> <td> </td> </tr> <tr> <td> </td> <td> </td> <td> </td> <td> </td> </tr> <tr> <td> </td> <td> </td> <td> </td> <td> </td> </tr> <tr> <td> </td> <td> </td> <td> </td> <td> </td> </tr> </tbody> </table>								PART NUMBER	DESCRIPTION	PART NUMBER	DESCRIPTION																																								
PART NUMBER	DESCRIPTION	PART NUMBER	DESCRIPTION																																																
<p>UNLESS OTHERWISE SPECIFIED DIMENSIONS ARE IN INCHES</p> <table border="1"> <thead> <tr> <th>XX</th> <th>XXX</th> <th>ANGLES</th> </tr> </thead> <tbody> <tr> <td>+/- .010</td> <td>+/- .005</td> <td>+/- 2.0deg</td> </tr> </tbody> </table>								XX	XXX	ANGLES	+/- .010	+/- .005	+/- 2.0deg																																						
XX	XXX	ANGLES																																																	
+/- .010	+/- .005	+/- 2.0deg																																																	
<table border="1"> <thead> <tr> <th colspan="2">CONTRACT NUMBER</th> <th>QTY</th> <th>PART NUMBER</th> <th>DESCRIPTION</th> <th>ITEM</th> </tr> </thead> <tbody> <tr> <td colspan="2"> </td> <td> </td> <td> </td> <td> </td> <td> </td> </tr> </tbody> </table>								CONTRACT NUMBER		QTY	PART NUMBER	DESCRIPTION	ITEM																																						
CONTRACT NUMBER		QTY	PART NUMBER	DESCRIPTION	ITEM																																														
<p>LIST OF MATERIAL</p> <table border="1"> <thead> <tr> <th>PREP</th> <th>B. ROSENFIELD</th> <th>10 / 09</th> </tr> </thead> <tbody> <tr> <td> </td> <td> </td> <td> </td> </tr> </tbody> </table>								PREP	B. ROSENFIELD	10 / 09																																									
PREP	B. ROSENFIELD	10 / 09																																																	
<p>2113 W. 850 N. Street Cedar City, Utah 84720 (435) 865-7100 (Fax)</p> <p>HP 39/600 MOTOR DIMENSIONAL DRAWING</p> <p>ASSY DWG</p> <p>SCALE: 1:1.5 SHEET 1 OF 1</p>																																																			

NOTES:
 1. MOTOR ASSEMBLY SHOWN WITH OVERALL EXTERIOR DIMENSIONS.

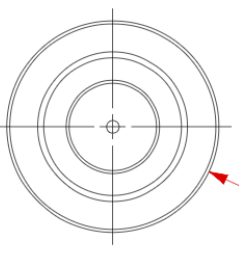
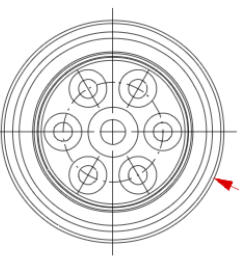
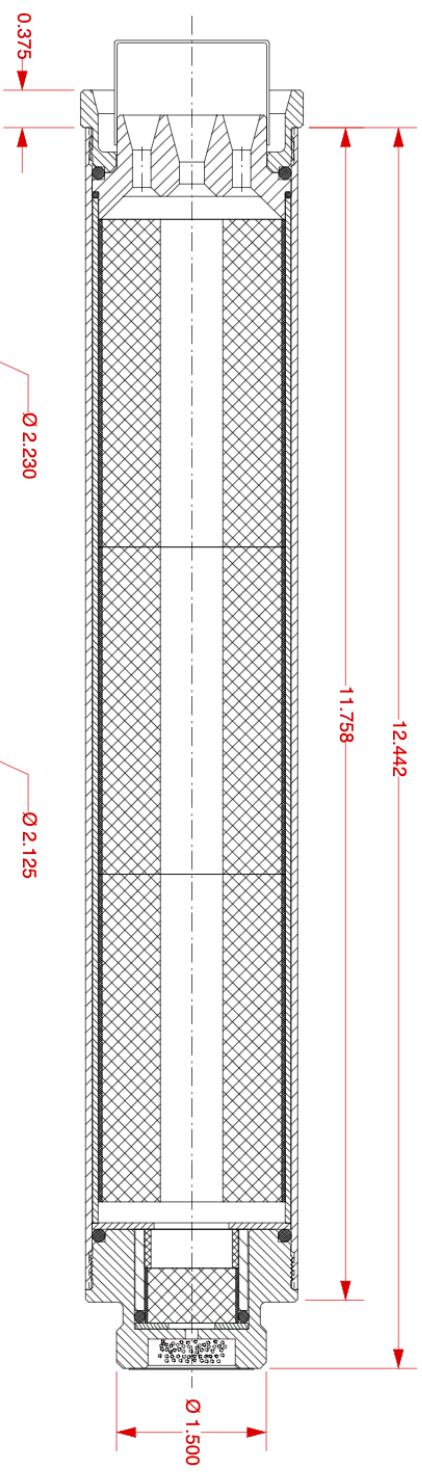

REVISIONS			
REV	DESCRIPTION	DATE	APPROVED
A	FIRST RELEASE ISSUE	10/21/08	
FUTURE			

8	7	6	5	4	3	2	1
<p>SUPPLIER DATA</p> <p>UNLESS OTHERWISE SPECIFIED DIMENSIONS ARE IN INCHES</p> <p>FINISH: XX ANGLES: XXX</p> <p>TOLERANCES: ±.010 ±.005 ±.005 ±.005</p> <p>CONTRACT NUMBER: 2113 W. 850 N. Street Cedar City, Utah 84720 (435) 865-7120 (Fax)</p> <p>HP 54/1280 MOTOR DIMENSIONAL DRAWING</p> <p>ASSY DWG</p> <p>SCALE: 1/16</p> <p>SHEET 1 OF 1</p>							
<p>RELOAD KIT IDENTIFICATION</p> <p>QTY: PART NUMBER: LIST OF MATERIAL: DESCRIPTION: ITEM:</p>							
<p>DESCRIPTION</p> <p>FINISH: SIZE: NUMBER: SCALE: 1/16</p>							
<p>PART NUMBER</p>							

NOTES:
1. MOTOR ASSEMBLY SHOWN WITH OVERALL EXTERIOR DIMENSIONS.

REVISIONS			
EFFECTIVITY	REV	DESCRIPTION	DATE APPROVED
FUTURE	A	FIRST RELEASE ISSUE	10/29/03

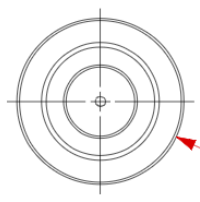
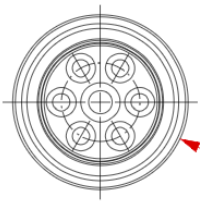
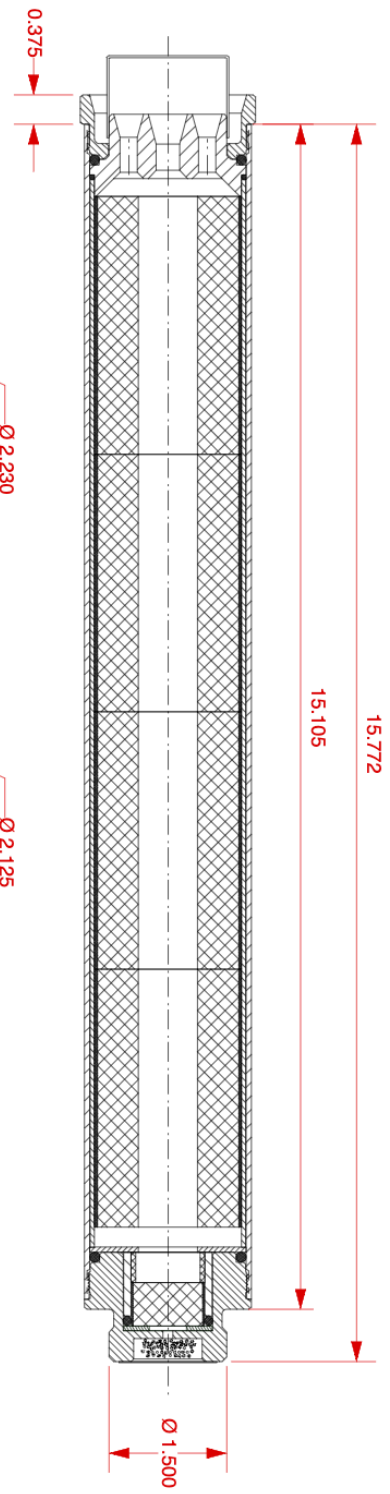

SUPPLIER DATA		RELOAD KIT IDENTIFICATION	
UNLESS OTHERWISE SPECIFIED DIMENSIONS ARE IN INCHES			
XX	XXX	ANGLES	
±.010	±.005	±.2 deg	
MATERIAL		CONTRACT NUMBER	
FINISH		PREP: B. ROSENFIELD 50.033	
PART NUMBER		CIRCUIT	
DESCRIPTION		APPRO	
LIST OF MATERIAL		DESCRIPTION	
ITEM		ITEM	
<p>ALROTECH 2119 W. 850 N. Street Chicago, IL 60642 (435) 865-7100 (PH) (435) 865-7120 (FAX)</p> <p>HP 54/706 MOTOR DIMENSIONAL DRAWING ASSY DWG</p>			
SCALE: 1/1.2		SHEET: 1 OF 1	

8 7 6 5 4 3 2 1

8 7 6 5 4 3 2 1

NOTES:
1. MOTOR ASSEMBLY SHOWN WITH OVERALL EXTERIOR DIMENSIONS.

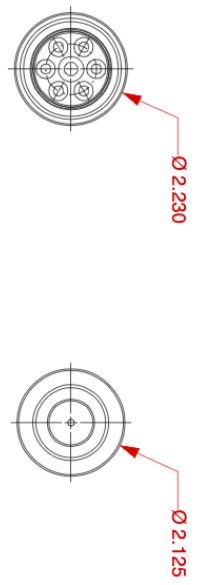
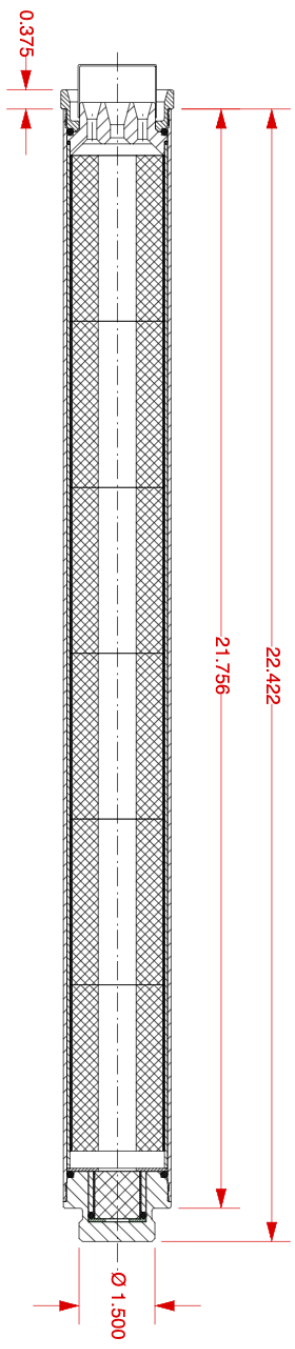

VIEW AFT CLOSURE VIEW FORWARD CLOSURE

SUPPLIER DATA		RELOAD KIT IDENTIFICATION	
UNLESS OTHERWISE SPECIFIED DIMENSIONS ARE IN INCHES			
XX	XX	ANGLES	QTY
+/- .010	+/- .005	+/- .249	PART NUMBER
MATERIAL		CONTRACT NUMBER	DESCRIPTION
FINISH		PREP. B. ROSENFIELD 30.03	LIST OF MATERIAL
PART NUMBER		CHKD	HP 54/2560 MOTOR
DESCRIPTION		APPRO	CONSUMER ASSURANCE
PART NUMBER		APPRO	2113 W. 850 N. Street
DESCRIPTION		SCALE 1/2	Cedar City, Utah 84720
PART NUMBER		SIZE	(435) 865-720 (Fax)
DESCRIPTION		NUMBER	HP 54/2560 MOTOR
PART NUMBER		ASSY DWG	4350 865-720 (Fax)
DESCRIPTION		SHEET 1 OF 1	

NOTES:
 1. MOTOR ASSEMBLY SHOWN WITH
 OVERALL EXTERIOR DIMENSIONS.

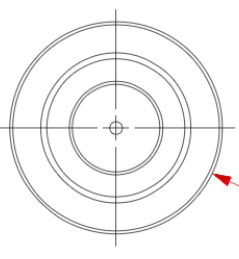
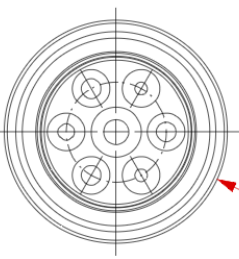
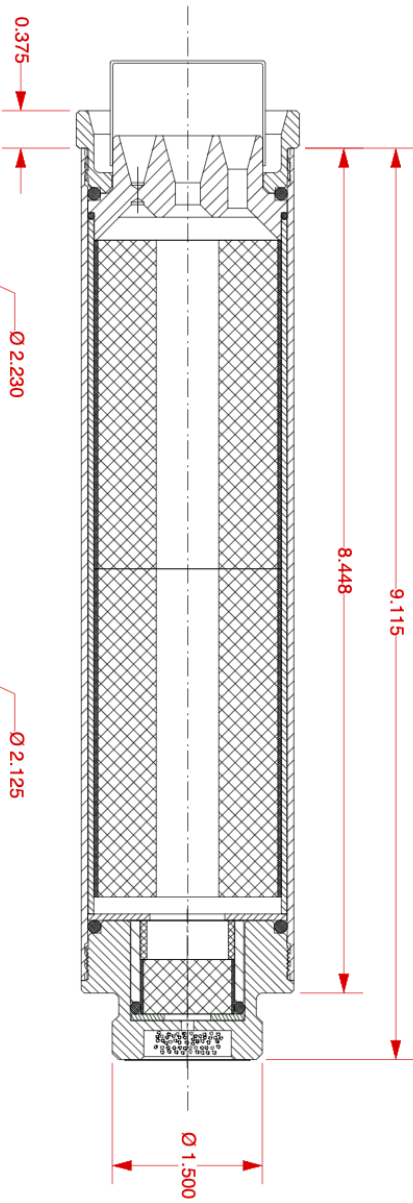

REVISIONS			
REV	DESCRIPTION	DATE	APPROVED
A	FIRST RELEASE ISSUE	10/21/03	

8	7	6	5	4	3	2	1													
							<table border="1"> <thead> <tr> <th colspan="4">REVISIONS</th> </tr> <tr> <th>REV</th> <th>DESCRIPTION</th> <th>DATE</th> <th>APPROVED</th> </tr> </thead> <tbody> <tr> <td>A</td> <td>FIRST RELEASE ISSUE</td> <td>10/21/03</td> <td></td> </tr> </tbody> </table>		REVISIONS				REV	DESCRIPTION	DATE	APPROVED	A	FIRST RELEASE ISSUE	10/21/03	
REVISIONS																				
REV	DESCRIPTION	DATE	APPROVED																	
A	FIRST RELEASE ISSUE	10/21/03																		
<p>1. MOTOR ASSEMBLY SHOWN WITH OVERALL EXTERIOR DIMENSIONS.</p>																				
<p>SUPPLIER DATA</p> <p>UNLESS OTHERWISE SPECIFIED DIMENSIONS ARE IN INCHES</p> <table border="1"> <tr> <td>XX</td> <td>XXX</td> <td>ANGLES</td> </tr> <tr> <td>+/- .010</td> <td>+/- .005</td> <td>+/- 2deg</td> </tr> </table>								XX	XXX	ANGLES	+/- .010	+/- .005	+/- 2deg							
XX	XXX	ANGLES																		
+/- .010	+/- .005	+/- 2deg																		
<p>RELOAD KIT IDENTIFICATION</p> <table border="1"> <tr> <th>QTY</th> <th>PART NUMBER</th> <th>DESCRIPTION</th> <th>ITEM</th> </tr> <tr> <td></td> <td></td> <td></td> <td></td> </tr> </table>								QTY	PART NUMBER	DESCRIPTION	ITEM									
QTY	PART NUMBER	DESCRIPTION	ITEM																	
<p>LIST OF MATERIAL</p> <table border="1"> <tr> <th>CONTRACT NUMBER</th> <th>DESCRIPTION</th> </tr> <tr> <td></td> <td></td> </tr> </table>								CONTRACT NUMBER	DESCRIPTION											
CONTRACT NUMBER	DESCRIPTION																			
<p>HP 54/852 MOTOR DIMENSIONAL DRAWING</p> <p>2113 W. 850 N. Street Cedar City, Utah 84720 (435) 865-7100 (PH) (435) 865-7120 (FAX)</p> <p>HP5P B. ROSENFIELD 10/183 CHKR APND APND</p> <p>SCALE: 1/1.5</p> <p>SIZE NUMBER A</p> <p>ASSY DWG</p>																				
<p>FINISH</p> <table border="1"> <tr> <th>DESCRIPTION</th> <th>FINISH</th> </tr> <tr> <td></td> <td></td> </tr> </table>								DESCRIPTION	FINISH											
DESCRIPTION	FINISH																			
<p>PART NUMBER</p> <table border="1"> <tr> <th>DESCRIPTION</th> <th>PART NUMBER</th> </tr> <tr> <td></td> <td></td> </tr> </table>								DESCRIPTION	PART NUMBER											
DESCRIPTION	PART NUMBER																			

NOTES:
1. MOTOR ASSEMBLY SHOWN WITH OVERALL EXTERIOR DIMENSIONS.

REVISIONS			
REV	DESCRIPTION	DATE	APPROVED
1	FIRST RELEASE ISSUE	1 / 8 / 12	

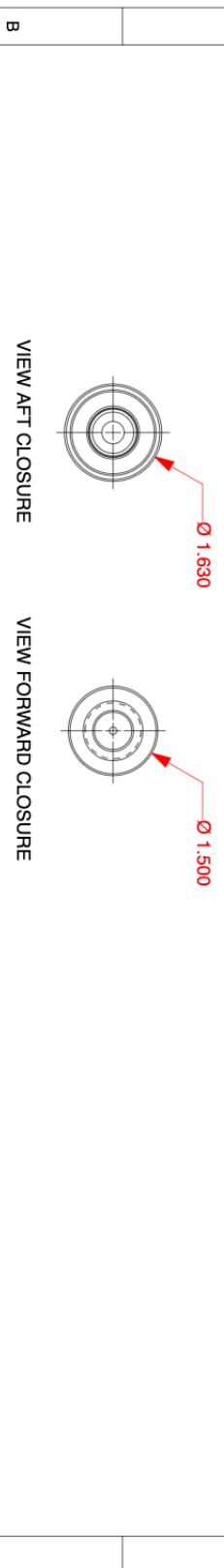
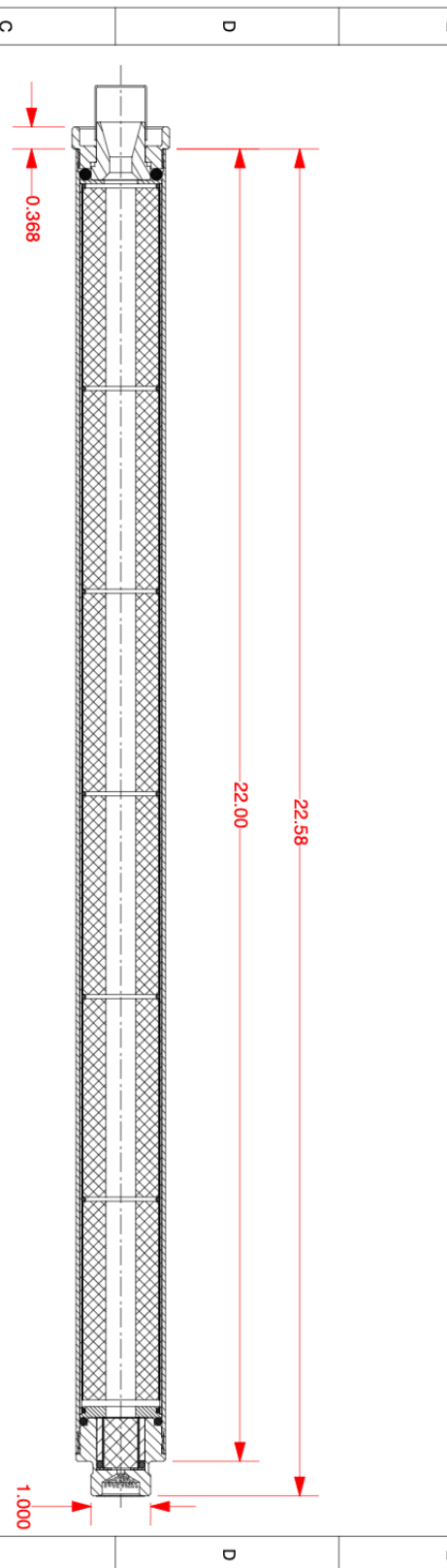

SUPPLIER DATA		RELOAD KIT IDENTIFICATION	
UNLESS OTHERWISE SPECIFIED DIMENSIONS ARE IN INCHES		QTY	PART NUMBER
.XX	±.010	.XXX	±.005
		ANGLES	±.2 deg.
MATERIAL		CONTRACT NUMBER	
NOTED		PREP. G. ROSENFIELD 1/12	
FINISH		CHGR	APRD
PART NUMBER		DESCRIPTION	
DESCRIPTION		LIST OF MATERIAL	
8		7	
6		5	
4		3	
2		1	

HP 38/1320 MOTOR DIMENSIONAL DRAWING ASSY DWG
 2113 W. 850 N. Street
 Cedar City, Utah 84721
 (435) 865-7120 (Fax)



Resources

In this section you can find the links to some dealers to get rocket parts.

Wizard Rockets: <http://wizardrockets.co.uk/>

Blackcat Rocketry: <https://www.blackcatrocketry.co.uk/>

Rockets and Things: <https://www.rocketsandthings.com/>

Sierrafox Hobbies: <https://www.sierrafoxbobbies.com/en/>

Eurospace Technology: <https://eurospacetechnology.eu/index.php>

Rocket and Roll: <https://www.rocketandroll.co.uk>

NB: There will be import duty and VAT to place on imported items.

Reading List

NB: it is NOT a requirement to read the textbook(s) below.

“Modern High-Power Rocketry” by Mark Canepa.